

SQX 130

Midrange specifications:

Name		HG-130SQX-2
DC resistance	Rdc	1,7 Ω
Nominal impedance	ZN	2 Ω
Resonance frequency	fs	70,0 HZ
Voice coil diameter		25 mm
Mechanical Q factor	Qms	3,18
Electrical Q factor	Qes	0,66
Total Q factor	Qts	0,55
Moving mass	Mms	15,95 g
Effective piston area	Sd	85 cm²
Mechanical resistance	Rms	2,4 Kg/s
Compliance	Cms	0,32 mm/N
Force factor	BL	4,0 Tm
Equivalent air volume	Vas	3,29 dm³
Efficiency	η	0,16 %
SPL 2,83V/1m		91,0 dB

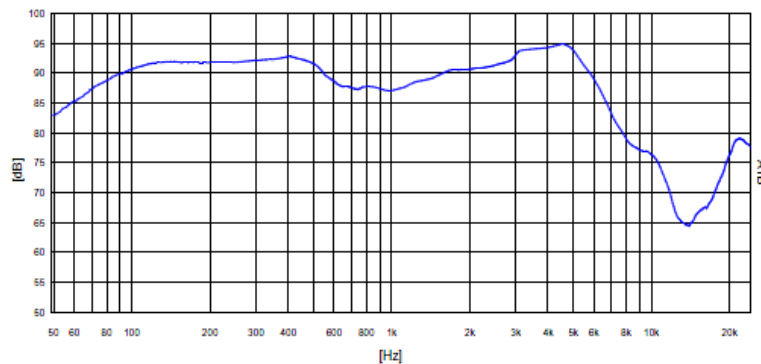

Cone: **Fiberglass**
 Spider: **Nomex**
 Surround: **Rubber**
 Coil former: **Aluminum**
 Basket: **Steel**
 Dust cap: **Silk**

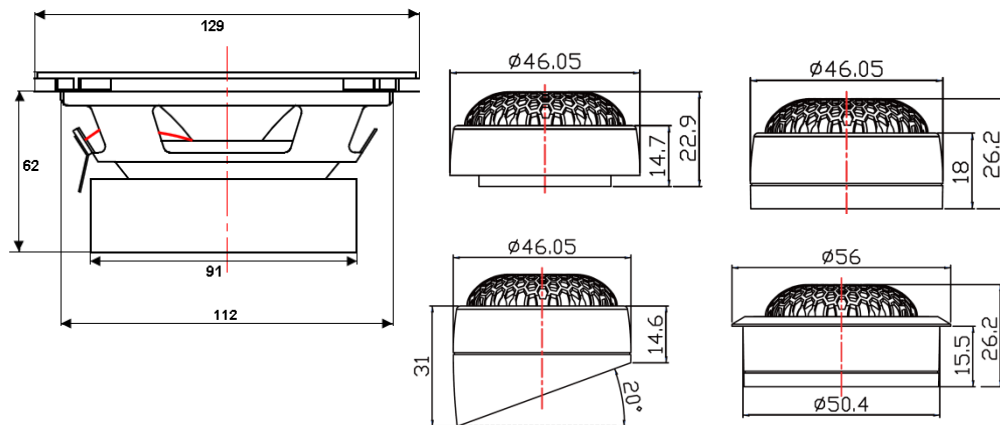

Tweeter specifications:

Name		HG-25SG
DC resistance	Rdc	3,3 Ω
Nominal impedance	ZN	4 Ω
Resonance frequency	fs	1580 HZ
Voice coil diameter		25 mm

